

Varenummer: 20193B20B20502SW
 Beskrivelse: E+G T-rørs holder
 GN 193-B20-B20-50-2-SW

Mål

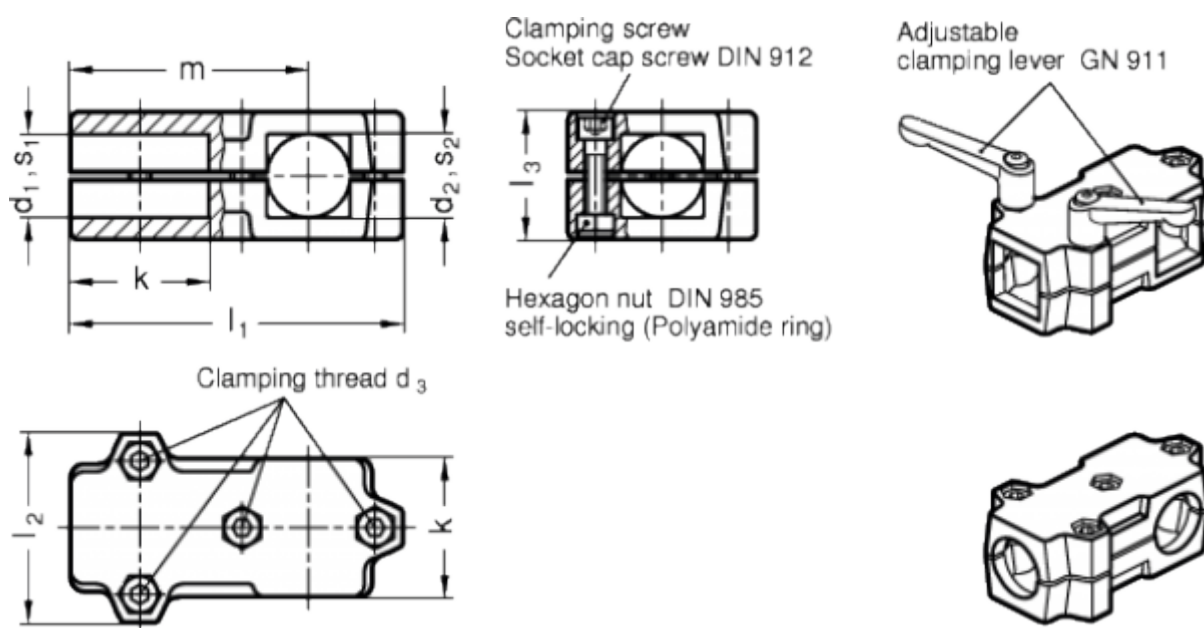

d1 = 20	s1	= -
d2 = 20	s2	= -
d3 = M8	Supplerende vare	= GN 911-M8-40
k = 50	Vægt i (g)	= 446
l1 = 120		
l2 = 68		
l3 = 46		
m = -		